

WOLFRAM

**INNOVATIVE
DEVELOPMENTS IN
AUTOMOTIVE
LIGHTING**

2022

WOLFRAM
PREMIUM QUALITY



www.wolfram.com.tr



WOLFRAM

WOLFRAM Automotive Bulbs, which takes its name from the first step of bulb production, manufactures its bulbs in fully automated, environment-friendly and nature-friendly factories located in Germany, which are equipped with high technology.

WOLFRAM Automotive Bulbs; manufactures front-rear and interior lighting bulbs of automobile, light commercial, heavy commercial and motorcycle vehicles all over the world.

WOLFRAM Automotive Bulbs provide complete customer satisfaction with its wide variety of options and high quality with its innovative automotive bulbs, especially standard bulbs. The desire to offer a better light option is the main source of our engineers working in WOLFRAM automotive bulbs, accelerating their continuous resource and development.

WOLFRAM Automotive Bulbs will enable people to see better now and in the future, move more comfortably and drive safely. Today, lighting bulbs need not only work and be permanent, but also provide their dealers with a competitive advantage in price.

WOLFRAM, the inventor of automotive bulb technology, adds innovation to everything it does with its pioneering high performance durability in halogen and miniature bulbs.

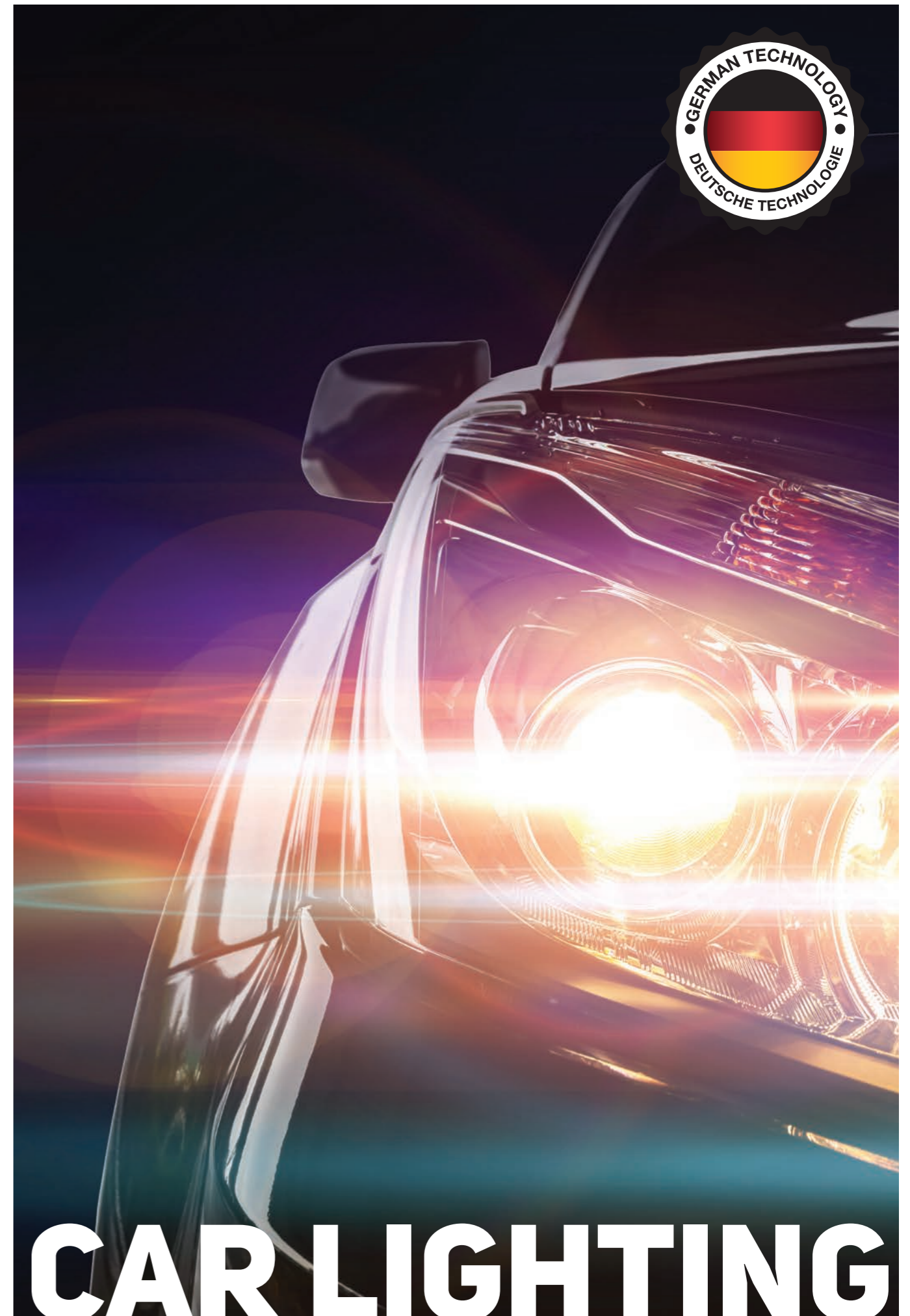

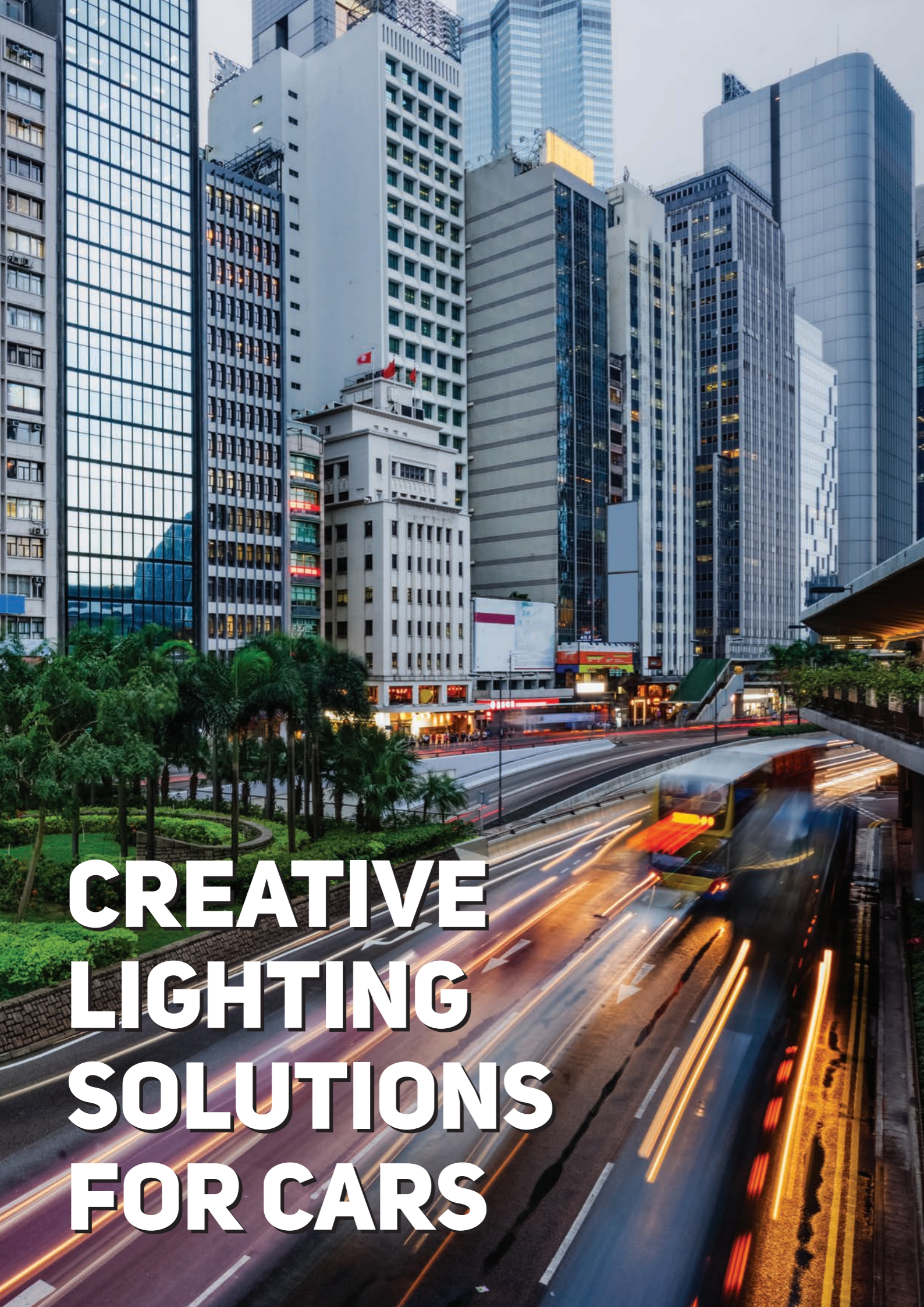

**CREATIVE
LIGHTING
SOLUTIONS
FOR CARS**



**WOLFRAM
HALOGEN
BULBS**



**HALOGEN
STANDARD LIGHT SERIES****HALOGEN
STANDARD LIGHT SERIES****WOLFRAM 22101**

| | |
|---------------------|----------------|
| Product Description | Standard Light |
| Ece | H1 |
| Volt | 12 Volt |
| Watt | 55 Watt |
| Base | P14.5s |
| Packaging Qty | 1 |
| Product Barcode | 8682005501014 |
| Bundle Qty | 10 |
| Bundle Barcode | 8682005504343 |
| Shipping Qty | 100 |
| Shipping Barcode | 8682005507672 |

**WOLFRAM 22113**

| | |
|---------------------|----------------|
| Product Description | Standard Light |
| Ece | H3 |
| Volt | 12 Volt |
| Watt | 100 Watt |
| Base | PK22s |
| Packaging Qty | 1 |
| Product Barcode | 8682005501045 |
| Bundle Qty | 10 |
| Bundle Barcode | 8682005504374 |
| Shipping Qty | 100 |
| Shipping Barcode | 8682005507702 |

**WOLFRAM 22102**

| | |
|---------------------|----------------|
| Product Description | Standard Light |
| Ece | H1 |
| Volt | 12 Volt |
| Watt | 100 Watt |
| Base | P14.5s |
| Packaging Qty | 1 |
| Product Barcode | 8682005501021 |
| Bundle Qty | 10 |
| Bundle Barcode | 8682005504350 |
| Shipping Qty | 100 |
| Shipping Barcode | 8682005507689 |

**WOLFRAM 22144**

| | |
|---------------------|----------------|
| Product Description | Standard Light |
| Ece | H4 |
| Volt | 12 Volt |
| Watt | 60/55 Watt |
| Base | P43t |
| Packaging Qty | 1 |
| Product Barcode | 8682005501052 |
| Bundle Qty | 10 |
| Bundle Barcode | 8682005504381 |
| Shipping Qty | 100 |
| Shipping Barcode | 8682005507719 |

**WOLFRAM 22103**

| | |
|---------------------|----------------|
| Product Description | Standard Light |
| Ece | H3 |
| Volt | 12 Volt |
| Watt | 55 Watt |
| Base | PK22s |
| Packaging Qty | 1 |
| Product Barcode | 8682005501038 |
| Bundle Qty | 10 |
| Bundle Barcode | 8682005504367 |
| Shipping Qty | 100 |
| Shipping Barcode | 8682005507696 |

**WOLFRAM 22145**

| | |
|---------------------|----------------|
| Product Description | Standard Light |
| Ece | H4 |
| Volt | 12 Volt |
| Watt | 100/90 Watt |
| Base | P43t |
| Packaging Qty | 1 |
| Product Barcode | 8682005501069 |
| Bundle Qty | 10 |
| Bundle Barcode | 8682005504398 |
| Shipping Qty | 100 |
| Shipping Barcode | 8682005507726 |

HALOGEN STANDARD LIGHT SERIES



WOLFRAM 22158

| | |
|---------------------|----------------|
| Product Description | Standard Light |
| Ece | H4 |
| Volt | 12 Volt |
| Watt | 60/55 Watt |
| Base | P45t |
| Packaging Qty | 1 |
| Product Barcode | 8682005501076 |
| Bundle Qty | 10 |
| Bundle Barcode | 8682005504404 |
| Shipping Qty | 100 |
| Shipping Barcode | 8682005507733 |



WOLFRAM 22159

| | |
|---------------------|----------------|
| Product Description | Standard Light |
| Ece | H4 |
| Volt | 12 Volt |
| Watt | 100/90 Watt |
| Base | P45t |
| Packaging Qty | 1 |
| Product Barcode | 8682005501083 |
| Bundle Qty | 10 |
| Bundle Barcode | 8682005504411 |
| Shipping Qty | 100 |
| Shipping Barcode | 8682005507740 |



WOLFRAM 22197

| | |
|---------------------|----------------|
| Product Description | Standard Light |
| Ece | H7 |
| Volt | 12 Volt |
| Watt | 55 Watt |
| Base | PX26d |
| Packaging Qty | 1 |
| Product Barcode | 8682005501090 |
| Bundle Qty | 10 |
| Bundle Barcode | 8682005504428 |
| Shipping Qty | 100 |
| Shipping Barcode | 8682005507757 |

HALOGEN STANDARD LIGHT SERIES

WOLFRAM

WOLFRAM 22218

| | |
|---------------------|----------------|
| Product Description | Standard Light |
| Ece | H18 |
| Volt | 12 Volt |
| Watt | 65 Watt |
| Base | PY26d-1 |
| Packaging Qty | 1 |
| Product Barcode | 8682005501106 |
| Bundle Qty | 10 |
| Bundle Barcode | 8682005504435 |
| Shipping Qty | 100 |
| Shipping Barcode | 8682005507764 |



WOLFRAM 22219

| | |
|---------------------|----------------|
| Product Description | Standard Light |
| Ece | H19 |
| Volt | 12 Volt |
| Watt | 60/55 Watt |
| Base | PU43t-3 |
| Packaging Qty | 1 |
| Product Barcode | 8682005501113 |
| Bundle Qty | 10 |
| Bundle Barcode | 8682005504442 |
| Shipping Qty | 100 |
| Shipping Barcode | 8682005507771 |



WOLFRAM 25121

| | |
|---------------------|-------------------|
| Product Description | Miniature Halogen |
| Ece | H5 |
| Volt | 12 Volt |
| Watt | 5 Watt |
| Base | BA9s |
| Packaging Qty | 10 |
| Product Barcode | 8682005502431 |
| Shipping Qty | 50 |
| Shipping Barcode | 8682005509096 |

HALOGEN STANDARD LIGHT SERIES



WOLFRAM 25132

| | |
|---------------------|-------------------|
| Product Description | Miniature Halogen |
| Ece | H6 |
| Volt | 12 Volt |
| Watt | 6 Watt |
| Base | BAX9s |
| Packaging Qty | 10 |
| Product Barcode | 8682005502448 |
| Shipping Qty | 50 |
| Shipping Barcode | 8682005509102 |



WOLFRAM 25133

| | |
|---------------------|-------------------|
| Product Description | Miniature Halogen |
| Ece | H10 |
| Volt | 12 Volt |
| Watt | 10 Watt |
| Base | BA9s |
| Packaging Qty | 10 |
| Product Barcode | 8682005502455 |
| Shipping Qty | 50 |
| Shipping Barcode | 8682005509119 |



WOLFRAM 25136

| | |
|---------------------|-------------------|
| Product Description | Miniature Halogen |
| Ece | H21 |
| Volt | 12 Volt |
| Watt | 21 Watt |
| Base | BAY9s |
| Packaging Qty | 10 |
| Product Barcode | 8682005502462 |
| Shipping Qty | 50 |
| Shipping Barcode | 8682005509126 |

HALOGEN STANDARD LIGHT SERIES

WOLFRAM

WOLFRAM 25137

| | |
|---------------------|-------------------|
| Product Description | Miniature Halogen |
| Ece | HY21 |
| Volt | 12 Volt |
| Watt | 21 Watt |
| Base | BAW9s |
| Packaging Qty | 10 |
| Product Barcode | 8682005502479 |
| Shipping Qty | 50 |
| Shipping Barcode | 8682005509133 |

HALOGEN STANDARD LIGHT SERIES



WOLFRAM 28880

| | |
|---------------------|----------------|
| Product Description | Standard Light |
| Ece | 880 |
| Volt | 12 Volt |
| Watt | 27 Watt |
| Base | PG13 |
| Packaging Qty | 1 |
| Product Barcode | 8682005501571 |
| Bundle Qty | 10 |
| Bundle Barcode | 8682005504909 |
| Shipping Qty | 100 |
| Shipping Barcode | 8682005508235 |



WOLFRAM 28881

| | |
|---------------------|----------------|
| Product Description | Standard Light |
| Ece | 881 |
| Volt | 12 Volt |
| Watt | 27 Watt |
| Base | PGJ13 |
| Packaging Qty | 1 |
| Product Barcode | 8682005501588 |
| Bundle Qty | 10 |
| Bundle Barcode | 8682005504916 |
| Shipping Qty | 100 |
| Shipping Barcode | 8682005508242 |



WOLFRAM 28886

| | |
|---------------------|----------------|
| Product Description | Standard Light |
| Ece | 886 |
| Volt | 12 Volt |
| Watt | 50 Watt |
| Base | PGJ13 |
| Packaging Qty | 1 |
| Product Barcode | 8682005501595 |
| Bundle Qty | 10 |
| Bundle Barcode | 8682005504923 |
| Shipping Qty | 100 |
| Shipping Barcode | 8682005508259 |

HALOGEN STANDARD LIGHT SERIES



WOLFRAM 29005

| | |
|---------------------|----------------|
| Product Description | Standard Light |
| Ece | HB3 |
| Volt | 12 Volt |
| Watt | 60 Watt |
| Base | P20d |
| Packaging Qty | 1 |
| Product Barcode | 8682005501601 |
| Bundle Qty | 10 |
| Bundle Barcode | 8682005504930 |
| Shipping Qty | 100 |
| Shipping Barcode | 8682005508266 |



WOLFRAM 29006

| | |
|---------------------|----------------|
| Product Description | Standard Light |
| Ece | HB4 |
| Volt | 12 Volt |
| Watt | 51 Watt |
| Base | P22d |
| Packaging Qty | 1 |
| Product Barcode | 8682005501618 |
| Bundle Qty | 10 |
| Bundle Barcode | 8682005504947 |
| Shipping Qty | 100 |
| Shipping Barcode | 8682005508273 |



WOLFRAM 29005 XS

| | |
|---------------------|----------------|
| Product Description | Standard Light |
| Ece | HB3A |
| Volt | 12 Volt |
| Watt | 60 Watt |
| Base | P20d |
| Packaging Qty | 1 |
| Product Barcode | 8682005501625 |
| Bundle Qty | 10 |
| Bundle Barcode | 8682005504954 |
| Shipping Qty | 100 |
| Shipping Barcode | 8682005508280 |

HALOGEN STANDARD LIGHT SERIES



WOLFRAM 29006 XS

| | |
|---------------------|----------------|
| Product Description | Standard Light |
| Ece | HB4A |
| Volt | 12 Volt |
| Watt | 51 Watt |
| Base | P22d |
| Packaging Qty | 1 |
| Product Barcode | 8682005501632 |
| Bundle Qty | 10 |
| Bundle Barcode | 8682005504961 |
| Shipping Qty | 100 |
| Shipping Barcode | 8682005508297 |



WOLFRAM 29011

| | |
|---------------------|----------------|
| Product Description | Standard Light |
| Ece | HIR 1 |
| Volt | 12 Volt |
| Watt | 65 Watt |
| Base | PX20d |
| Packaging Qty | 1 |
| Product Barcode | 8682005501649 |
| Bundle Qty | 10 |
| Bundle Barcode | 8682005504978 |
| Shipping Qty | 100 |
| Shipping Barcode | 8682005508303 |



WOLFRAM 29012

| | |
|---------------------|----------------|
| Product Description | Standard Light |
| Ece | HIR 2 |
| Volt | 12 Volt |
| Watt | 55 Watt |
| Base | PX22d |
| Packaging Qty | 1 |
| Product Barcode | 8682005501656 |
| Bundle Qty | 10 |
| Bundle Barcode | 8682005504985 |
| Shipping Qty | 100 |
| Shipping Barcode | 8682005508310 |

HALOGEN STANDARD LIGHT SERIES

WOLFRAM

WOLFRAM 29218

| | |
|---------------------|----------------|
| Product Description | Standard Light |
| Ece | H8 |
| Volt | 12 Volt |
| Watt | 35 Watt |
| Base | PGJ19-1 |
| Packaging Qty | 1 |
| Product Barcode | 8682005501663 |
| Bundle Qty | 10 |
| Bundle Barcode | 8682005504992 |
| Shipping Qty | 100 |
| Shipping Barcode | 8682005508327 |



WOLFRAM 29219

| | |
|---------------------|----------------|
| Product Description | Standard Light |
| Ece | H9 |
| Volt | 12 Volt |
| Watt | 65 Watt |
| Base | PGJ19-5 |
| Packaging Qty | 1 |
| Product Barcode | 8682005501670 |
| Bundle Qty | 10 |
| Bundle Barcode | 8682005505005 |
| Shipping Qty | 100 |
| Shipping Barcode | 8682005508334 |



WOLFRAM 29310

| | |
|---------------------|----------------|
| Product Description | Standard Light |
| Ece | H10 |
| Volt | 12 Volt |
| Watt | 42 Watt |
| Base | PY20d |
| Packaging Qty | 1 |
| Product Barcode | 8682005501687 |
| Bundle Qty | 10 |
| Bundle Barcode | 8682005505012 |
| Shipping Qty | 100 |
| Shipping Barcode | 8682005508341 |

HALOGEN STANDARD LIGHT SERIES



WOLFRAM 29311

| | |
|---------------------|----------------|
| Product Description | Standard Light |
| Ece | H11 |
| Volt | 12 Volt |
| Watt | 55 Watt |
| Base | PGJ19-2 |
| Packaging Qty | 1 |
| Product Barcode | 8682005501694 |
| Bundle Qty | 10 |
| Bundle Barcode | 8682005505029 |
| Shipping Qty | 100 |
| Shipping Barcode | 8682005508358 |



WOLFRAM 29312

| | |
|---------------------|----------------|
| Product Description | Standard Light |
| Ece | H12 |
| Volt | 12 Volt |
| Watt | 53 Watt |
| Base | PZ20d |
| Packaging Qty | 1 |
| Product Barcode | 8682005501700 |
| Bundle Qty | 10 |
| Bundle Barcode | 8682005505036 |
| Shipping Qty | 100 |
| Shipping Barcode | 8682005508365 |



WOLFRAM 29313

| | |
|---------------------|----------------|
| Product Description | Standard Light |
| Ece | H13 |
| Volt | 12 Volt |
| Watt | 60/55 Watt |
| Base | P26.4t |
| Packaging Qty | 1 |
| Product Barcode | 8682005501717 |
| Bundle Qty | 10 |
| Bundle Barcode | 8682005505043 |
| Shipping Qty | 100 |
| Shipping Barcode | 8682005508372 |

HALOGEN STANDARD LIGHT SERIES

WOLFRAM

WOLFRAM 29315

| | |
|---------------------|----------------|
| Product Description | Standard Light |
| Ece | H15 |
| Volt | 12 Volt |
| Watt | 15/55 Watt |
| Base | PGJ23t-1 |
| Packaging Qty | 1 |
| Product Barcode | 8682005501724 |
| Bundle Qty | 10 |
| Bundle Barcode | 8682005505050 |
| Shipping Qty | 100 |
| Shipping Barcode | 8682005508389 |



WOLFRAM 29316

| | |
|---------------------|----------------|
| Product Description | Standard Light |
| Ece | H16 |
| Volt | 12 Volt |
| Watt | 19 Watt |
| Base | PGJ19-3 |
| Packaging Qty | 1 |
| Product Barcode | 8682005501731 |
| Bundle Qty | 10 |
| Bundle Barcode | 8682005505067 |
| Shipping Qty | 100 |
| Shipping Barcode | 8682005508396 |



WOLFRAM 29951

| | |
|---------------------|----------------|
| Product Description | Standard Light |
| Ece | R2 |
| Volt | 12 Volt |
| Watt | 45/40 Watt |
| Base | P45t |
| Packaging Qty | 1 |
| Product Barcode | 8682005502813 |
| Bundle Qty | 10 |
| Bundle Barcode | 8682005506149 |
| Shipping Qty | 100 |
| Shipping Barcode | 8682005509478 |



**FROM
DARKNESS
TO LIGHT**



WOLFRAM
NIGHT
VISION



HALOGEN NIGHT VISION SERIES

+150% EXTRA LIGHT +20% WHITER



WOLFRAM 22101 NV

Product Description NV +150% Extra Light +20% Whiter
Ece H1
Volt 12 Volt
Watt 55 Watt
Base P14.5s
Packaging Qty 1 set
Product Barcode 8682005502585
Shipping Qty 10 set
Shipping Barcode 8682005509249



WOLFRAM 22103 NV

Product Description NV +150% Extra Light +20% Whiter
Ece H3
Volt 12 Volt
Watt 55 Watt
Base PK22s
Packaging Qty 1 set
Product Barcode 8682005502592
Shipping Qty 10 set
Shipping Barcode 8682005509256



WOLFRAM 22144 NV

Product Description NV +150% Extra Light +20% Whiter
Ece H4
Volt 12 Volt
Watt 60/55 Watt
Base P43t
Packaging Qty 1 set
Product Barcode 8682005502608
Shipping Qty 10 set
Shipping Barcode 8682005509263

HALOGEN NIGHT VISION SERIES

+150% EXTRA LIGHT +20% WHITER



WOLFRAM 22197 NV

Product Description NV +150% Extra Light +20% Whiter
Ece H7
Volt 12 Volt
Watt 55 Watt
Base PX26d
Packaging Qty 1 set
Product Barcode 8682005502615
Shipping Qty 10 set
Shipping Barcode 8682005509270



WOLFRAM 29005 NV

Product Description NV +150% Extra Light +20% Whiter
Ece HB3
Volt 12 Volt
Watt 60 Watt
Base P20d
Packaging Qty 1 set
Product Barcode 8682005502622
Shipping Qty 10 set
Shipping Barcode 8682005509287



WOLFRAM 29006 NV

Product Description NV +150% Extra Light +20% Whiter
Ece HB4
Volt 12 Volt
Watt 51 Watt
Base P22d
Packaging Qty 1 set
Product Barcode 8682005502639
Shipping Qty 10 set
Shipping Barcode 8682005509294

HALOGEN
NIGHT VISION SERIES
+150% EXTRA LIGHT +20% WHITER



WOLFRAM 29218 NV

Product Description NV +150% Extra Light
+20% Whiter
Ece H8
Volt 12 Volt
Watt 35 Watt
Base PGJ19-1
Packaging Qty 1 set
Product Barcode 8682005502653
Shipping Qty 10 set
Shipping Barcode 8682005509317



WOLFRAM 29311 NV

Product Description NV +150% Extra Light
+20% Whiter
Ece H11
Volt 12 Volt
Watt 55 Watt
Base PGJ19-2
Packaging Qty 1 set
Product Barcode 8682005502660
Shipping Qty 10 set
Shipping Barcode 8682005509324



WOLFRAM 29316 NV

Product Description NV +150% Extra Light
+20% Whiter
Ece H16
Volt 12 Volt
Watt 19 Watt
Base PGJ19-3
Packaging Qty 1 set
Product Barcode 8682005502677
Shipping Qty 10 set
Shipping Barcode 8682005509331



WOLFRAM
SKY
BLUE



HALOGEN
SKY BLUE SERIES
WHITE LIGHT



WOLFRAM 22101 SB

Product Description SB White Light
Ece H1
Volt 12 Volt
Watt 100 Watt
Base P14.5s
Packaging Qty 1 set
Product Barcode 8682005502493
Shipping Qty 10 set
Shipping Barcode 8682005509157



WOLFRAM 22103 SB

Product Description SB White Light
Ece H3
Volt 12 Volt
Watt 100 Watt
Base PK22s
Packaging Qty 1 set
Product Barcode 8682005502509
Shipping Qty 10 set
Shipping Barcode 8682005509164



WOLFRAM 22144 SB

Product Description SB White Light
Ece H4
Volt 12 Volt
Watt 100/90 Watt
Base P43t
Packaging Qty 1 set
Product Barcode 8682005502516
Shipping Qty 10 set
Shipping Barcode 8682005509171

HALOGEN
SKY BLUE SERIES
WHITE LIGHT



WOLFRAM 22197 SB

Product Description SB White Light
Ece H7
Volt 12 Volt
Watt 100 Watt
Base PX26d
Packaging Qty 1 set
Product Barcode 8682005502523
Shipping Qty 10 set
Shipping Barcode 8682005509188



WOLFRAM 29005 SB

Product Description SB White Light
Ece HB3
Volt 12 Volt
Watt 100 Watt
Base P20d
Packaging Qty 1 set
Product Barcode 8682005502530
Shipping Qty 10 set
Shipping Barcode 8682005509195



WOLFRAM 29006 SB

Product Description SB White Light
Ece HB4
Volt 12 Volt
Watt 80 Watt
Base P22d
Packaging Qty 1 set
Product Barcode 8682005502547
Shipping Qty 10 set
Shipping Barcode 8682005509294

HALOGEN
SKY BLUE SERIES
WHITE LIGHT



WOLFRAM 29218 SB

Product Description SB White Light
 Ece H8
 Volt 12 Volt
 Watt 35 Watt
 Base PGJ19-1
 Packaging Qty 1 set
 Product Barcode 8682005502554
 Shipping Qty 10 set
 Shipping Barcode 8682005509317



WOLFRAM 29311 SB

Product Description SB White Light
 Ece H11
 Volt 12 Volt
 Watt 55 Watt
 Base PGJ19-2
 Packaging Qty 1 set
 Product Barcode 8682005502561
 Shipping Qty 10 set
 Shipping Barcode 8682005509324



WOLFRAM
XENON
BULBS



XENON 4300K SERIES (BROWN STICK)



WOLFRAM 28311

| | |
|---------------------|----------------------|
| Product Description | Xenon Standard Light |
| Ece | D1S |
| Kelvin | 4300 K |
| Volt | 12 / 24 Volt |
| Watt | 35 Watt |
| Base | PK32d-2 |
| Packaging Qty | 1 |
| Product Barcode | 8682005501373 |
| Shipping Qty | 10 |
| Shipping Barcode | 8682005508037 |



WOLFRAM 28312

| | |
|---------------------|----------------------|
| Product Description | Xenon Standard Light |
| Ece | D2S |
| Kelvin | 4300K |
| Volt | 12 / 24 Volt |
| Watt | 35 Watt |
| Base | P32d-2 |
| Packaging Qty | 1 |
| Product Barcode | 8682005501380 |
| Shipping Qty | 10 |
| Shipping Barcode | 8682005508044 |



WOLFRAM 28313

| | |
|---------------------|----------------------|
| Product Description | Xenon Standard Light |
| Ece | D3S |
| Kelvin | 4300K |
| Volt | 12 / 24 Volt |
| Watt | 35 Watt |
| Base | PK32d-5 |
| Packaging Qty | 1 |
| Product Barcode | 8682005501397 |
| Shipping Qty | 10 |
| Shipping Barcode | 8682005508051 |

XENON 4300K SERIES (BROWN STICK)



WOLFRAM 28314

| | |
|---------------------|----------------------|
| Product Description | Xenon Standard Light |
| Ece | D4S |
| Kelvin | 4300K |
| Volt | 12 / 24 Volt |
| Watt | 35 Watt |
| Base | P32d-5 |
| Packaging Qty | 1 |
| Product Barcode | 8682005501403 |
| Shipping Qty | 10 |
| Shipping Barcode | 8682005508068 |



WOLFRAM 28315

| | |
|---------------------|----------------------|
| Product Description | Xenon Standard Light |
| Ece | D5S |
| Kelvin | 4300K |
| Volt | 12 / 24 Volt |
| Watt | 25 Watt |
| Base | PK32d-7 |
| Packaging Qty | 1 |
| Product Barcode | 8682005501410 |
| Shipping Qty | 10 |
| Shipping Barcode | 8682005508075 |



WOLFRAM 28318

| | |
|---------------------|----------------------|
| Product Description | Xenon Standard Light |
| Ece | D8S |
| Kelvin | 4300K |
| Volt | 12 / 24 Volt |
| Watt | 25 Watt |
| Base | PK32d-1 |
| Packaging Qty | 1 |
| Product Barcode | 8682005501427 |
| Shipping Qty | 10 |
| Shipping Barcode | 8682005508082 |

**XENON
4300K SERIES (BROWN STICK)****WOLFRAM 28321**

| | |
|---------------------|----------------|
| Product Description | Xenon Standard |
| Ece | Light |
| Kelvin | D1R |
| Volt | 12 - 24 Volt |
| Watt | 35 Watt |
| Base | PK32d-3 |
| Packaging Qty | 1 |
| Product Barcode | 8682005502936 |
| Shipping Qty | 10 |
| Shipping Barcode | 8682005509591 |

**XENON
6000K SERIES (BLUE STICK)****WOLFRAM 28421**

| | |
|---------------------|-------------------|
| Product Description | Xenon White Light |
| Ece | D1S |
| Kelvin | 6000K |
| Volt | 12 / 24 Volt |
| Watt | 35 Watt |
| Base | PK32d-2 |
| Packaging Qty | 1 |
| Product Barcode | 8682005501434 |
| Shipping Qty | 10 |
| Shipping Barcode | 8682005508099 |

**WOLFRAM 28322**

| | |
|---------------------|----------------------|
| Product Description | Xenon Standard Light |
| Ece | D2R |
| Kelvin | 4300K |
| Volt | 12 / 24 Volt |
| Watt | 35 Watt |
| Base | P32d-3 |
| Packaging Qty | 1 |
| Product Barcode | 8682005502745 |
| Shipping Qty | 10 |
| Shipping Barcode | 8682005509409 |

**WOLFRAM 28422**

| | |
|---------------------|-------------------|
| Product Description | Xenon White Light |
| Ece | D2S |
| Kelvin | 6000K |
| Volt | 12 / 24 Volt |
| Watt | 35 Watt |
| Base | P32d-2 |
| Packaging Qty | 1 |
| Product Barcode | 8682005501441 |
| Shipping Qty | 10 |
| Shipping Barcode | 8682005508105 |

**WOLFRAM 28324**

| | |
|---------------------|----------------------|
| Product Description | Xenon Standard Light |
| Ece | D4R |
| Kelvin | 4300K |
| Volt | 12 / 24 Volt |
| Watt | 35 Watt |
| Base | P32d-6 |
| Packaging Qty | 1 |
| Product Barcode | 8682005502769 |
| Shipping Qty | 10 |
| Shipping Barcode | 8682005509423 |

**WOLFRAM 28423**

| | |
|---------------------|-------------------|
| Product Description | Xenon White Light |
| Ece | D3S |
| Kelvin | 6000K |
| Volt | 12 / 24 Volt |
| Watt | 35 Watt |
| Base | PK32d-5 |
| Packaging Qty | 1 |
| Product Barcode | 8682005501458 |
| Shipping Qty | 10 |
| Shipping Barcode | 8682005508112 |

XENON 6000K SERIES (BLUE STICK)



WOLFRAM 28424

| | |
|---------------------|-------------------|
| Product Description | Xenon White Light |
| Ece | D4S |
| Kelvin | 6000K |
| Volt | 12 / 24 Volt |
| Watt | 35 Watt |
| Base | P32d-5 |
| Packaging Qty | 1 |
| Product Barcode | 8682005501465 |
| Shipping Qty | 10 |
| Shipping Barcode | 8682005508129 |



WOLFRAM 28425

| | |
|---------------------|-------------------|
| Product Description | Xenon White Light |
| Ece | D5S |
| Kelvin | 6000K |
| Volt | 12 - 24 Volt |
| Watt | 25 Watt |
| Base | PK32d-7 |
| Packaging Qty | 1 |
| Product Barcode | 8682005503131 |
| Shipping Qty | 10 |
| Shipping Barcode | 8682005509799 |



WOLFRAM 28431

| | |
|---------------------|-------------------|
| Product Description | Xenon White Light |
| Ece | D1R |
| Kelvin | 6000K |
| Volt | 12 - 24 Volt |
| Watt | 35 Watt |
| Base | PK32d-3 |
| Packaging Qty | 1 |
| Product Barcode | 8682005502943 |
| Shipping Qty | 10 |
| Shipping Barcode | 8682005509607 |

XENON 6000K SERIES (BLUE STICK)



WOLFRAM 28428

| | |
|---------------------|-------------------|
| Product Description | Xenon White Light |
| Ece | D8S |
| Kelvin | 6000K |
| Volt | 12 / 24 Volt |
| Watt | 25 Watt |
| Base | PK32d-1 |
| Packaging Qty | 1 |
| Product Barcode | 8682005502820 |
| Shipping Qty | 10 |
| Shipping Barcode | 8682005509485 |



WOLFRAM 28432

| | |
|---------------------|-------------------|
| Product Description | Xenon White Light |
| Ece | D2R |
| Kelvin | 6000K |
| Volt | 12 / 24 Volt |
| Watt | 35 Watt |
| Base | P32d-3 |
| Packaging Qty | 1 |
| Product Barcode | 8682005502752 |
| Shipping Qty | 10 |
| Shipping Barcode | 8682005509416 |



WOLFRAM 28434

| | |
|---------------------|-------------------|
| Product Description | Xenon White Light |
| Ece | D4R |
| Kelvin | 6000K |
| Volt | 12 / 24 Volt |
| Watt | 35 Watt |
| Base | P32d-6 |
| Packaging Qty | 1 |
| Product Barcode | 8682005502776 |
| Shipping Qty | 10 |
| Shipping Barcode | 8682005509430 |

XENON LONG LIFE SERIES (WHITE STICK)



WOLFRAM 28531

| | |
|---------------------|-----------------|
| Product Description | Xenon Long Life |
| Ece | D1S |
| Kelvin | 4300K |
| Volt | 12 / 24 Volt |
| Watt | 35 Watt |
| Base | PK32d-2 |
| Packaging Qty | 1 |
| Product Barcode | 8682005501472 |
| Shipping Qty | 10 |
| Shipping Barcode | 8682005508136 |



WOLFRAM 28532

| | |
|---------------------|-----------------|
| Product Description | Xenon Long Life |
| Ece | D2S |
| Kelvin | 4300K |
| Volt | 12 / 24 Volt |
| Watt | 35 Watt |
| Base | P32d-2 |
| Packaging Qty | 1 |
| Product Barcode | 8682005501489 |
| Shipping Qty | 10 |
| Shipping Barcode | 8682005508143 |



WOLFRAM 28533

| | |
|---------------------|-----------------|
| Product Description | Xenon Long Life |
| Ece | D3S |
| Kelvin | 4300K |
| Volt | 12 / 24 Volt |
| Watt | 35 Watt |
| Base | PK32d-5 |
| Packaging Qty | 1 |
| Product Barcode | 8682005501496 |
| Shipping Qty | 10 |
| Shipping Barcode | 8682005508150 |

XENON LONG LIFE SERIES (WHITE STICK)

WOLFRAM

WOLFRAM 28534

| | |
|---------------------|-----------------|
| Product Description | Xenon Long Life |
| Ece | D4S |
| Kelvin | 4300K |
| Volt | 12 / 24 Volt |
| Watt | 35 Watt |
| Base | P32d-5 |
| Packaging Qty | 1 |
| Product Barcode | 8682005501502 |
| Shipping Qty | 10 |
| Shipping Barcode | 8682005508167 |

XENON 4300K ULTRAVIOLET



WOLFRAM 28641

| | |
|---------------------|----------------------------------|
| Product Description | Xenon Standard Light Ultraviolet |
| Ece | D1S |
| Kelvin | 4300K |
| Volt | 12 - 24 Volt |
| Watt | 35 Watt |
| Base | PK32d-2 |
| Packaging Qty | 1 |
| Product Barcode | 8682005501519 |
| Shipping Qty | 10 |
| Shipping Barcode | 8682005508174 |



WOLFRAM 28642

| | |
|---------------------|----------------------------------|
| Product Description | Xenon Standard Light Ultraviolet |
| Ece | D2S |
| Kelvin | 4300K |
| Volt | 12 - 24 Volt |
| Watt | 35 Watt |
| Base | P32d-2 |
| Packaging Qty | 1 |
| Product Barcode | 8682005501526 |
| Shipping Qty | 10 |
| Shipping Barcode | 8682005508181 |



WOLFRAM 28643

| | |
|---------------------|----------------------------------|
| Product Description | Xenon Standard Light Ultraviolet |
| Ece | D3S |
| Kelvin | 4300K |
| Volt | 12 - 24 Volt |
| Watt | 35 Watt |
| Base | PK32d-5 |
| Packaging Qty | 1 |
| Product Barcode | 8682005501533 |
| Shipping Qty | 10 |
| Shipping Barcode | |

XENON 4300K ULTRAVIOLET



WOLFRAM 28644

| | |
|---------------------|----------------------------------|
| Product Description | Xenon Standard Light Ultraviolet |
| Ece | D4S |
| Kelvin | 4300K |
| Volt | 12 - 24 Volt |
| Watt | 35 Watt |
| Base | P32d-5 |
| Packaging Qty | 1 |
| Product Barcode | 8682005501540 |
| Shipping Qty | 10 |
| Shipping Barcode | 8682005508204 |



WOLFRAM 28645

| | |
|---------------------|----------------------------------|
| Product Description | Xenon Standard Light Ultraviolet |
| Ece | D5S |
| Kelvin | 4300K |
| Volt | 12 - 24 Volt |
| Watt | 25 Watt |
| Base | PK32d-7 |
| Packaging Qty | 1 |
| Product Barcode | 8682005501557 |
| Shipping Qty | 10 |
| Shipping Barcode | 8682005508211 |



WOLFRAM 28648

| | |
|---------------------|----------------------------------|
| Product Description | Xenon Standard Light Ultraviolet |
| Ece | D8S |
| Kelvin | 4300K |
| Volt | 12 - 24 Volt |
| Watt | 25 Watt |
| Base | PK32d-1 |
| Packaging Qty | 1 |
| Product Barcode | 8682005501564 |
| Shipping Qty | 10 |
| Shipping Barcode | 8682005508228 |

XENON 6000K ULTRAVIOLET



WOLFRAM 28751

| | |
|---------------------|----------------------------------|
| Product Description | Xenon White Light Ultraviolet |
| Ece | D1S |
| Kelvin | 6000K |
| Volt | 12 - 24 Volt |
| Watt | 35 Watt |
| Base | PK32d-2 |
| Packaging Qty | 1 |
| Product Barcode | 8682005502875 |
| Shipping Qty | 10 |
| Shipping Barcode | 8682005509539 |



WOLFRAM 28752

| | |
|---------------------|----------------------------------|
| Product Description | Xenon White Light Ultraviolet |
| Ece | D2S |
| Kelvin | 6000K |
| Volt | 12 - 24 Volt |
| Watt | 35 Watt |
| Base | P32d-2 |
| Packaging Qty | 1 |
| Product Barcode | 8682005502882 |
| Shipping Qty | 10 |
| Shipping Barcode | 8682005509546 |



WOLFRAM 28753

| | |
|---------------------|----------------------------------|
| Product Description | Xenon White Light Ultraviolet |
| Ece | D3S |
| Kelvin | 6000K |
| Volt | 12 - 24 Volt |
| Watt | 35 Watt |
| Base | PK32d-5 |
| Packaging Qty | 1 |
| Product Barcode | 8682005502899 |
| Shipping Qty | 10 |
| Shipping Barcode | 8682005509553 |

XENON 6000K ULTRAVIOLET



WOLFRAM 28754

| | |
|---------------------|----------------------------------|
| Product Description | Xenon White Light Ultraviolet |
| Ece | D4S |
| Kelvin | 6000K |
| Volt | 12 - 24 Volt |
| Watt | 35 Watt |
| Base | P32d-5 |
| Packaging Qty | 1 |
| Product Barcode | 8682005502905 |
| Shipping Qty | 10 |
| Shipping Barcode | 8682005509560 |



WOLFRAM 28755

| | |
|---------------------|----------------------------------|
| Product Description | Xenon White Light Ultraviolet |
| Ece | D5S |
| Kelvin | 6000K |
| Volt | 12 - 24 Volt |
| Watt | 25 Watt |
| Base | PK32d-7 |
| Packaging Qty | 1 |
| Product Barcode | 8682005502912 |
| Shipping Qty | 10 |
| Shipping Barcode | 8682005509577 |



WOLFRAM 28758

| | |
|---------------------|----------------------------------|
| Product Description | Xenon White Light Ultraviolet |
| Ece | D8S |
| Kelvin | 6000K |
| Volt | 12 - 24 Volt |
| Watt | 25 Watt |
| Base | PK32d-1 |
| Packaging Qty | 1 |
| Product Barcode | 8682005502929 |
| Shipping Qty | 10 |
| Shipping Barcode | 8682005509584 |

XENON 8000K ICE BLUE



WOLFRAM 28521

Product Description Xenon Ice Blue Light
 Ece D1S
 Kelvin 8000K
 Volt 12 - 24 Volt
 Watt 35 Watt
 Base PK32d-2
 Packaging Qty 1
 Product Barcode 8682005508860
 Shipping Qty 12
 Shipping Barcode 8682005509884



WOLFRAM 28522

Product Description Xenon Ice Blue Light
 Ece D2S
 Kelvin 8000K
 Volt 12 - 24 Volt
 Watt 35 Watt
 Base P32d-2
 Packaging Qty 1
 Product Barcode 8682005508891
 Shipping Qty 12
 Shipping Barcode 8682005508914



WOLFRAM 28523

Product Description Xenon Ice Blue Light
 Ece D3S
 Kelvin 8000K
 Volt 12 - 24 Volt
 Watt 35 Watt
 Base PK32d-5
 Packaging Qty 1
 Product Barcode 8682005508921
 Shipping Qty 12
 Shipping Barcode 8682005508945



WOLFRAM STOP SIGNAL



STOP SIGNAL STOP SIGNAL SERIES



WOLFRAM 27853

| | |
|---------------------|---------------|
| Product Description | Metal Base |
| Ece | T4W |
| Volt | 12 Volt |
| Watt | 4 Watt |
| Base | BA9s |
| Packaging Qty | 10 |
| Product Barcode | 8682005501298 |
| Shipping Qty | 50 |
| Shipping Barcode | 8682005507955 |



WOLFRAM 27867

| | |
|---------------------|---------------|
| Product Description | Metal Base |
| Ece | R5W |
| Volt | 12 Volt |
| Watt | 5 Watt |
| Base | BA15s |
| Packaging Qty | 10 |
| Product Barcode | 8682005501304 |
| Shipping Qty | 50 |
| Shipping Barcode | 8682005507962 |



WOLFRAM 27870

| | |
|---------------------|---------------|
| Product Description | Metal Base |
| Ece | R10W |
| Volt | 12 Volt |
| Watt | 10 Watt |
| Base | BA15s |
| Packaging Qty | 10 |
| Product Barcode | 8682005501311 |
| Shipping Qty | 50 |
| Shipping Barcode | 8682005507979 |

STOP SIGNAL STOP SIGNAL SERIES

WOLFRAM



WOLFRAM 27877

| | |
|---------------------|---------------|
| Product Description | Metal Base |
| Ece | RY10W |
| Volt | 12 Volt |
| Watt | 10 Watt |
| Base | BA15s |
| Packaging Qty | 10 |
| Product Barcode | 8682005501328 |
| Shipping Qty | 50 |
| Shipping Barcode | 8682005507986 |



WOLFRAM 27893

| | |
|---------------------|---------------|
| Product Description | Metal Base |
| Ece | P21W |
| Volt | 12 Volt |
| Watt | 21 Watt |
| Base | BA15s |
| Packaging Qty | 10 |
| Product Barcode | 8682005501335 |
| Shipping Qty | 50 |
| Shipping Barcode | 8682005507993 |



WOLFRAM 27897

| | |
|---------------------|---------------|
| Product Description | Metal Base |
| Ece | PY21W |
| Volt | 12 Volt |
| Watt | 21 Watt |
| Base | BAU15s |
| Packaging Qty | 10 |
| Product Barcode | 8682005501342 |
| Shipping Qty | 50 |
| Shipping Barcode | 8682005508006 |

STOP SIGNAL STOP SIGNAL SERIES



WOLFRAM 27899

| | |
|---------------------|---------------|
| Product Description | Metal Base |
| Ece | PY21W |
| Volt | 12 Volt |
| Watt | 21 Watt |
| Base | BA15s |
| Packaging Qty | 10 |
| Product Barcode | 8682005502806 |
| Shipping Qty | 50 |
| Shipping Barcode | 8682005509461 |

STOP SIGNAL STOP SIGNAL SERIES



RED

WOLFRAM 27906

| | |
|---------------------|---------------|
| Product Description | Metal Base |
| Ece | PR21W |
| Volt | 12 Volt |
| Watt | 21 Watt |
| Base | BAW9s |
| Packaging Qty | 10 |
| Product Barcode | 8682005502714 |
| Shipping Qty | 50 |
| Shipping Barcode | 8682005509379 |



RED

WOLFRAM 27903

| | |
|---------------------|---------------|
| Product Description | Metal Base |
| Ece | PR21W |
| Volt | 12 Volt |
| Watt | 21 Watt |
| Base | BAU15s |
| Packaging Qty | 10 |
| Product Barcode | 8682005502691 |
| Shipping Qty | 50 |
| Shipping Barcode | 8682005509355 |



WOLFRAM 27916

| | |
|---------------------|---------------|
| Product Description | Metal Base |
| Ece | P21/5W |
| Volt | 12 Volt |
| Watt | 21/5 Watt |
| Base | BAY15d |
| Packaging Qty | 10 |
| Product Barcode | 8682005501359 |
| Shipping Qty | 50 |
| Shipping Barcode | 8682005508013 |



RED

WOLFRAM 27905

| | |
|---------------------|---------------|
| Product Description | Metal Base |
| Ece | PR21W |
| Volt | 12 Volt |
| Watt | 21 Watt |
| Base | BA15s |
| Packaging Qty | 10 |
| Product Barcode | 8682005502707 |
| Shipping Qty | 50 |
| Shipping Barcode | 8682005509362 |



WOLFRAM 27918

| | |
|---------------------|---------------|
| Product Description | Metal Base |
| Ece | P21/4W |
| Volt | 12 Volt |
| Watt | 21/4 Watt |
| Base | BAZ15d |
| Packaging Qty | 10 |
| Product Barcode | 8682005501366 |
| Shipping Qty | 50 |
| Shipping Barcode | 8682005508020 |

STOP SIGNAL STOP SIGNAL SERIES



WOLFRAM 27937

Product Description Metal Base
Ece PY21/5W
Volt 12 Volt
Watt 21/5 Watt
Base BAY15d
Packaging Qty 10
Product Barcode 8682005502837
Shipping Qty 50
Shipping Barcode 8682005509492



RED

WOLFRAM 27939

Product Description Metal Base
Ece PR21/5W
Volt 12 Volt
Watt 21 Watt
Base BAW15d
Packaging Qty 10
Product Barcode 8682005503186
Shipping Qty 50
Shipping Barcode 8682005509843



WOLFRAM 27976

Product Description Metal Base
Ece P21/5W
Volt 12 Volt
Watt 21/5 Watt
Base BA15d
Packaging Qty 10
Product Barcode 8682005502738
Shipping Qty 50
Shipping Barcode 8682005509393

STOP SIGNAL PLASTIC SOCET



WOLFRAM 23156

Product Description Plastic Socet
 Miniature Bulbs
Ece P27W
Volt 12 Volt
Watt 27W
Base W2.5x16d
Packaging Qty 10
Product Barcode 8682005508679
Shipping Qty 50
Shipping Barcode 8682005508886



WOLFRAM 23157

Product Description Plastic Socet
 Miniature Bulbs
Ece P27/7W
Volt 12 Volt
Watt 27/7W
Base W2.5x16q
Packaging Qty 10
Product Barcode 8682005508709
Shipping Qty 50
Shipping Barcode 8682005508716



WOLFRAM 23158

Product Description Plastic Socet
 Miniature Bulbs
Ece PY27/7W
Volt 12 Volt
Watt 27/7W
Base W2.5x16q
Packaging Qty 10
Product Barcode 8682005508730
Shipping Qty 50
Shipping Barcode 8682005508747

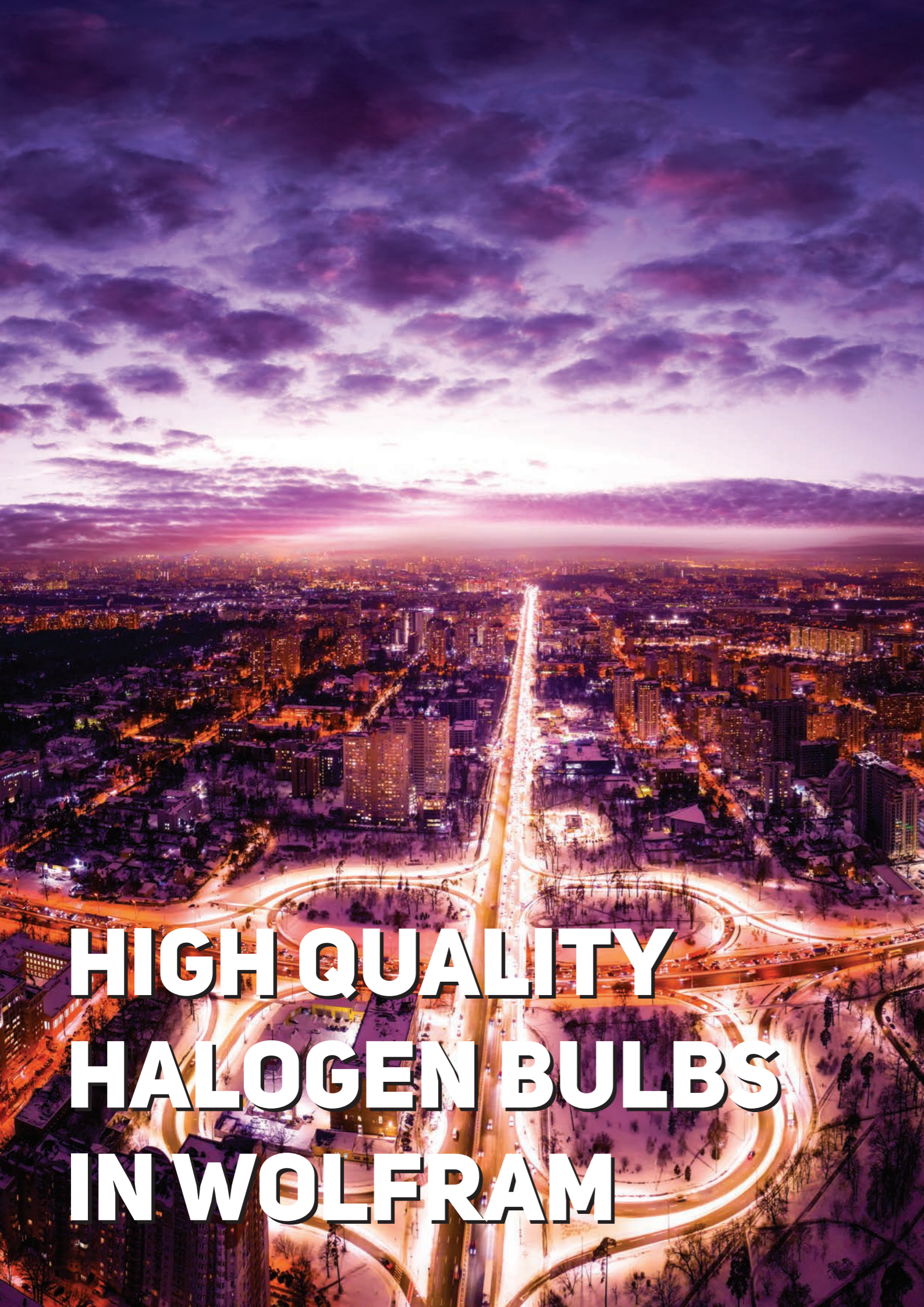

HIGH QUALITY HALOGEN BULBS IN WOLFRAM

**STOP SIGNAL
MINI SERIES**



WOLFRAM 26112

Product Description Glass Wedge Base
Ece T5
Volt 12 Volt
Watt 1,2 Watt
Base W2x4.6d
Packaging Qty 10
Product Barcode 8682005501175
Shipping Qty 50
Shipping Barcode 8682005507832



WOLFRAM 26113

Product Description Glass Wedge Base
Ece T10
Volt 12 Volt
Watt 3 Watt
Base W2.1x9.5d
Packaging Qty 10
Product Barcode 8682005501182
Shipping Qty 50
Shipping Barcode 8682005507849



WOLFRAM 26305

Product Description Glass Wedge Base
Ece T10
Volt 12 Volt
Watt 5 Watt
Base W2.1x9.5d
Packaging Qty 10
Product Barcode 8682005501199
Shipping Qty 50
Shipping Barcode 8682005507856

STOP SIGNAL MINI SERIES



WOLFRAM 26307

| | |
|---------------------|------------------|
| Product Description | Glass Wedge Base |
| Ece | T10 |
| Volt | 12 Volt |
| Watt | 5 Watt |
| Base | W2.1x9.5d |
| Packaging Qty | 10 |
| Product Barcode | 8682005501205 |
| Shipping Qty | 50 |
| Shipping Barcode | 8682005507863 |



WOLFRAM 26315

| | |
|---------------------|------------------|
| Product Description | Glass Wedge Base |
| Ece | T15 |
| Volt | 12 Volt |
| Watt | 16 Watt |
| Base | W2.1x9.5d |
| Packaging Qty | 10 |
| Product Barcode | 8682005501212 |
| Shipping Qty | 50 |
| Shipping Barcode | 8682005507870 |



WOLFRAM 26317

| | |
|---------------------|------------------|
| Product Description | Glass Wedge Base |
| Ece | T15 |
| Volt | 12 Volt |
| Watt | 16 Watt |
| Base | W2.1x9.5d |
| Packaging Qty | 10 |
| Product Barcode | 8682005501229 |
| Shipping Qty | 50 |
| Shipping Barcode | 8682005507887 |

STOP SIGNAL MINI SERIES



WOLFRAM 26420

| | |
|---------------------|------------------|
| Product Description | Glass Wedge Base |
| Ece | T20 |
| Volt | 12 Volt |
| Watt | 21 Watt |
| Base | W3x16d |
| Packaging Qty | 10 |
| Product Barcode | 8682005501236 |
| Shipping Qty | 50 |
| Shipping Barcode | 8682005507894 |



WOLFRAM 26427

| | |
|---------------------|------------------|
| Product Description | Glass Wedge Base |
| Ece | T20 |
| Volt | 12 Volt |
| Watt | 21 Watt |
| Base | WX3x16d |
| Packaging Qty | 10 |
| Product Barcode | 8682005501243 |
| Shipping Qty | 50 |
| Shipping Barcode | 8682005507900 |



WOLFRAM 26430

| | |
|---------------------|------------------|
| Product Description | Glass Wedge Base |
| Ece | T20 |
| Volt | 12 Volt |
| Watt | 21/5 Watt |
| Base | W3x16q |
| Packaging Qty | 10 |
| Product Barcode | 8682005501250 |
| Shipping Qty | 50 |
| Shipping Barcode | 8682005507917 |



WOLFRAM 26437

| | |
|---------------------|------------------|
| Product Description | Glass Wedge Base |
| Ece | T20 Ampul |
| Volt | 12 Volt |
| Watt | 21/5 Watt |
| Base | W3x16q |
| Packaging Qty | 11 |
| Product Barcode | 8682005502851 |
| Shipping Qty | 50 |
| Shipping Barcode | 8682005509515 |

STOP SIGNAL FESTOON SERIES



WOLFRAM 26505

| | |
|---------------------|---------------|
| Product Description | Festoon 36 mm |
| Ece | CW5 |
| Volt | 12 Volt |
| Watt | 5 Watt |
| Base | SV8.5-8 |
| Packaging Qty | 10 |
| Product Barcode | 8682005501267 |
| Shipping Qty | 50 |
| Shipping Barcode | 8682005507924 |



WOLFRAM 26510

| | |
|---------------------|---------------|
| Product Description | Festoon 41 mm |
| Ece | CW10 |
| Volt | 12 Volt |
| Watt | 10 Watt |
| Base | SV8.5-8 |
| Packaging Qty | 10 |
| Product Barcode | 8682005501274 |
| Shipping Qty | 50 |
| Shipping Barcode | 8682005507931 |



WOLFRAM 26512

| | |
|---------------------|---------------|
| Product Description | Festoon 31 mm |
| Ece | CW10 |
| Volt | 12 Volt |
| Watt | 10 Watt |
| Base | SV8.5-8 |
| Packaging Qty | 10 |
| Product Barcode | 8682005501281 |
| Shipping Qty | 50 |
| Shipping Barcode | 8682005507948 |

STOP SIGNAL PLASTIC SOCKET MINIATURE BULBS



WOLFRAM 30100

| | |
|---------------------|----------------------------------|
| Product Description | Plastic Socket Miniature Bulb |
| Volt | 12 Volt |
| Watt | 1,2W |
| Base | B8,5d |
| Packaging Qty | 10 |
| Product Barcode | 8682005506293 |
| Shipping Qty | 50 |
| Shipping Barcode | 8682005506316 |



WOLFRAM 30102

| | |
|---------------------|----------------------------------|
| Product Description | Plastic Socket Miniature Bulb |
| Volt | 12 Volt |
| Watt | 2W |
| Base | B8,5d |
| Packaging Qty | 10 |
| Product Barcode | 8682005506323 |
| Shipping Qty | 50 |
| Shipping Barcode | 8682005506347 |



WOLFRAM 30103

| | |
|---------------------|----------------------------------|
| Product Description | Plastic Socket Miniature Bulb |
| Volt | 12 Volt |
| Watt | 1,2W |
| Base | BX8,5d |
| Packaging Qty | 10 |
| Product Barcode | 8682005506354 |
| Shipping Qty | 50 |
| Shipping Barcode | 8682005506378 |

STOP SIGNAL PLASTIC SOCKET MINIATURE BULBS



WOLFRAM 30104

Product Description Plastic Socket
Miniature Bulb
Volt 12 Volt
Watt 2W
Base BX8,5d
Packaging Qty 10
Product Barcode 8682005506385
Shipping Qty 50
Shipping Barcode 8682005506408

STOP SIGNAL PLASTIC SOCKET MINIATURE BULBS



WOLFRAM 30107

Product Description Plastic Socket
Miniature Bulb
Volt 12 Volt
Watt 1,5W
Base BX8,4d
Packaging Qty 10
Product Barcode 8682005506545
Shipping Qty 50
Shipping Barcode 8682005506569



WOLFRAM 30105

Product Description Plastic Socket
Miniature Bulb
Volt 12 Volt
Watt 1,2W
Base BX8,4d
Packaging Qty 10
Product Barcode 8682005506446
Shipping Qty 50
Shipping Barcode 8682005506477



WOLFRAM 30110

Product Description Plastic Socket
Miniature Bulb
Volt 12 Volt
Watt 0,84W
Base
Packaging Qty 10
Product Barcode 8682005506576
Shipping Qty 50
Shipping Barcode 8682005506590



WOLFRAM 30106

Product Description Plastic Socket
Miniature Bulb
Volt 12 Volt
Watt 2W
Base BX8,4d
Packaging Qty 10
Product Barcode 8682005506484
Shipping Qty 50
Shipping Barcode 8682005506507



WOLFRAM 30111

Product Description Plastic Socket
Miniature Bulb
Volt 12 Volt
Watt 1,2W
Base
Packaging Qty 10
Product Barcode 8682005506606
Shipping Qty 50
Shipping Barcode 8682005506620

STOP SIGNAL PLASTIC SOCKET MINIATURE BULBS



WOLFRAM 30112

| | |
|---------------------|----------------------------------|
| Product Description | Plastic Socket Miniature Bulb |
| Volt | 12 Volt |
| Watt | 1,2W |
| Base | |
| Packaging Qty | 10 |
| Product Barcode | 8682005506637 |
| Shipping Qty | 50 |
| Shipping Barcode | 8682005506651 |



WOLFRAM 30113

| | |
|---------------------|----------------------------------|
| Product Description | Plastic Socket Miniature Bulb |
| Volt | 12 Volt |
| Watt | 1,2W |
| Base | B8,3d |
| Packaging Qty | 10 |
| Product Barcode | 8682005506668 |
| Shipping Qty | 50 |
| Shipping Barcode | 8682005504473 |



WOLFRAM 30114

| | |
|---------------------|----------------------------------|
| Product Description | Plastic Socket Miniature Bulb |
| Volt | 12 Volt |
| Watt | 1,2W |
| Base | EBS-R4 |
| Packaging Qty | 10 |
| Product Barcode | 8682005504480 |
| Shipping Qty | 50 |
| Shipping Barcode | 8682005508631 |



WOLFRAM 30193

| | |
|---------------------|--------------------------------------|
| Product Description | Plastic Socket Miniature Bulb SET |
| Product Barcode | 8682005508761 |



TRUCK LIGHTING



**WE ARE WITH
YOU ON
DIFFICULT
CONDITIONS**



**WOLFRAM
HALOGEN
BULBS**



**HALOGEN
STANDARD LIGHT SERIES****WOLFRAM 34121**

| | |
|---------------------|----------------|
| Product Description | Standard Light |
| Ece | H1 |
| Volt | 24 Volt |
| Watt | 70 Watt |
| Base | P14.5s |
| Packaging Qty | 1 |
| Product Barcode | 8682005501748 |
| Bundle Qty | 10 |
| Bundle Barcode | 8682005505074 |
| Shipping Qty | 100 |
| Shipping Barcode | 8682005508402 |

**WOLFRAM 34122**

| | |
|---------------------|----------------|
| Product Description | Standard Light |
| Ece | H1 |
| Volt | 24 Volt |
| Watt | 100 Watt |
| Base | P14.5s |
| Packaging Qty | 1 |
| Product Barcode | 8682005501755 |
| Bundle Qty | 10 |
| Bundle Barcode | 8682005505081 |
| Shipping Qty | 100 |
| Shipping Barcode | 8682005508419 |

**WOLFRAM 34123**

| | |
|---------------------|----------------|
| Product Description | Standard Light |
| Ece | H3 |
| Volt | 24 Volt |
| Watt | 70 Watt |
| Base | PK22s |
| Packaging Qty | 1 |
| Product Barcode | 8682005501762 |
| Bundle Qty | 10 |
| Bundle Barcode | 8682005505098 |
| Shipping Qty | 100 |
| Shipping Barcode | 8682005508426 |

**HALOGEN
STANDARD LIGHT SERIES****WOLFRAM 34124**

| | |
|---------------------|----------------|
| Product Description | Standard Light |
| Ece | H3 |
| Volt | 24 Volt |
| Watt | 100 Watt |
| Base | PK22s |
| Packaging Qty | 1 |
| Product Barcode | 8682005501779 |
| Bundle Qty | 10 |
| Bundle Barcode | 8682005505104 |
| Shipping Qty | 100 |
| Shipping Barcode | 8682005508433 |

**WOLFRAM 34204**

| | |
|---------------------|----------------|
| Product Description | Standard Light |
| Ece | H4 |
| Volt | 24 Volt |
| Watt | 75/70 Watt |
| Base | P43t |
| Packaging Qty | 1 |
| Product Barcode | 8682005501786 |
| Bundle Qty | 10 |
| Bundle Barcode | 8682005505111 |
| Shipping Qty | 100 |
| Shipping Barcode | 8682005508440 |

**WOLFRAM 34206**

| | |
|---------------------|----------------|
| Product Description | Standard Light |
| Ece | H4 |
| Volt | 24 Volt |
| Watt | 100/90 Watt |
| Base | P43t |
| Packaging Qty | 1 |
| Product Barcode | 8682005501793 |
| Bundle Qty | 10 |
| Bundle Barcode | 8682005505128 |
| Shipping Qty | 100 |
| Shipping Barcode | 8682005508457 |

**HALOGEN
STANDARD LIGHT SERIES****WOLFRAM 34208**

| | |
|---------------------|----------------|
| Product Description | Standard Light |
| Ece | H4 |
| Volt | 24 Volt |
| Watt | 75/70 Watt |
| Base | P45t |
| Packaging Qty | 1 |
| Product Barcode | 8682005501809 |
| Bundle Qty | 10 |
| Bundle Barcode | 8682005505135 |
| Shipping Qty | 100 |
| Shipping Barcode | 8682005508464 |

**HALOGEN
STANDARD LIGHT SERIES****WOLFRAM 34237**

| | |
|---------------------|----------------|
| Product Description | Standard Light |
| Ece | H7 Ampul |
| Volt | 24 Volt |
| Watt | 100 Watt |
| Base | PX26d |
| Packaging Qty | 2 |
| Product Barcode | 8682005502868 |
| Bundle Qty | 10 |
| Bundle Barcode | 8682005506194 |
| Shipping Qty | 100 |
| Shipping Barcode | 8682005509522 |

**WOLFRAM 34210**

| | |
|---------------------|----------------|
| Product Description | Standard Light |
| Ece | H4 |
| Volt | 24 Volt |
| Watt | 100/90 Watt |
| Base | P45t |
| Packaging Qty | 1 |
| Product Barcode | 8682005501816 |
| Bundle Qty | 10 |
| Bundle Barcode | 8682005505142 |
| Shipping Qty | 100 |
| Shipping Barcode | 8682005508471 |

**WOLFRAM 34311**

| | |
|---------------------|----------------|
| Product Description | Standard Light |
| Ece | H11 |
| Volt | 24 Volt |
| Watt | 70 Watt |
| Base | PGJ19-2 |
| Packaging Qty | 1 |
| Product Barcode | 8682005501830 |
| Bundle Qty | 10 |
| Bundle Barcode | 8682005505166 |
| Shipping Qty | 100 |
| Shipping Barcode | 8682005508495 |

**WOLFRAM 34217**

| | |
|---------------------|----------------|
| Product Description | Standard Light |
| Ece | H7 |
| Volt | 24 Volt |
| Watt | 70 Watt |
| Base | PX26d |
| Packaging Qty | 1 |
| Product Barcode | 8682005501823 |
| Bundle Qty | 10 |
| Bundle Barcode | 8682005505159 |
| Shipping Qty | 100 |
| Shipping Barcode | 8682005508488 |

**WOLFRAM 34315**

| | |
|---------------------|----------------|
| Product Description | Standard Light |
| Ece | H15 |
| Volt | 24 Volt |
| Watt | 20/60 Watt |
| Base | PGJ23t-1 |
| Packaging Qty | 1 |
| Product Barcode | 8682005501847 |
| Bundle Qty | 10 |
| Bundle Barcode | 8682005505173 |
| Shipping Qty | 100 |
| Shipping Barcode | 8682005508501 |



WOLFRAM 34358

Product Description Miniature Halogen
 Ece H21
 Volt 24 Volt
 Watt 21 Watt
 Base BAY9s
 Packaging Qty 1
 Product Barcode 8682005502486
 Bundle Qty 10
 Bundle Barcode 8682005505814
 Shipping Qty 50
 Shipping Barcode 8682005509140

TRUCK VISION SERIES

+150% EXTRA LIGHT / HEAVY DUTY / LONG LIFE



WOLFRAM 34217 TV

Product Description TV +150% Extra Light
 Heavy Duty
 Long Life
 Ece H7
 Volt 24 Volt
 Watt 70 Watt
 Base PX26d
 Packaging Qty 1 set
 Product Barcode 8682005502790
 Shipping Qty 10 set
 Shipping Barcode 8682005509454



WOLFRAM STOP SIGNAL



**STOP SIGNAL
STOP SIGNAL SERIES****WOLFRAM 34753**

| | |
|---------------------|---------------|
| Product Description | Metal Base |
| Ece | T4W |
| Volt | 24 Volt |
| Watt | 4 Watt |
| Base | BA9s |
| Packaging Qty | 10 |
| Product Barcode | 8682005501915 |
| Shipping Qty | 50 |
| Shipping Barcode | 8682005508570 |

**STOP SIGNAL
STOP SIGNAL SERIES****WOLFRAM 34793**

| | |
|---------------------|---------------|
| Product Description | Metal Base |
| Ece | P21W |
| Volt | 24 Volt |
| Watt | 21 Watt |
| Base | BA15s |
| Packaging Qty | 10 |
| Product Barcode | 8682005501946 |
| Shipping Qty | 50 |
| Shipping Barcode | 8682005508600 |

**WOLFRAM 34767**

| | |
|---------------------|---------------|
| Product Description | Metal Base |
| Ece | R5W |
| Volt | 24 Volt |
| Watt | 5 Watt |
| Base | BA15s |
| Packaging Qty | 10 |
| Product Barcode | 8682005501922 |
| Shipping Qty | 50 |
| Shipping Barcode | 8682005508587 |

**WOLFRAM 34797**

| | |
|---------------------|---------------|
| Product Description | Metal Base |
| Ece | PY21W |
| Volt | 24 Volt |
| Watt | 21 Watt |
| Base | BAU15s |
| Packaging Qty | 10 |
| Product Barcode | 8682005501953 |
| Shipping Qty | 50 |
| Shipping Barcode | 8682005508617 |

**WOLFRAM 34770**

| | |
|---------------------|---------------|
| Product Description | Metal Base |
| Ece | R10W |
| Volt | 24 Volt |
| Watt | 10 Watt |
| Base | BA15s |
| Packaging Qty | 10 |
| Product Barcode | 8682005501939 |
| Shipping Qty | 50 |
| Shipping Barcode | 8682005508594 |

**WOLFRAM 34816**

| | |
|---------------------|---------------|
| Product Description | Metal Base |
| Ece | P21/5W |
| Volt | 24 Volt |
| Watt | 21/5 Watt |
| Base | BAY15d |
| Packaging Qty | 10 |
| Product Barcode | 8682005501960 |
| Shipping Qty | 50 |
| Shipping Barcode | 8682005508624 |

**STOP SIGNAL
STOP SIGNAL SERIES****WOLFRAM 34918**

| | |
|---------------------|---------------|
| Product Description | Metal Base |
| Ece | P21/4W |
| Volt | 24 Volt |
| Watt | 21/4 Watt |
| Base | BAZ15d |
| Packaging Qty | 10 |
| Product Barcode | 8682005502721 |
| Shipping Qty | 50 |
| Shipping Barcode | 8682005509386 |

**STOP SIGNAL
MINI SERIES****WOLFRAM 34411**

| | |
|---------------------|------------------|
| Product Description | Glass Wedge Base |
| Ece | T5 |
| Volt | 24 Volt |
| Watt | 1,2 Watt |
| Base | W2x4.6d |
| Packaging Qty | 10 |
| Product Barcode | 8682005501854 |
| Shipping Qty | 50 |
| Shipping Barcode | 8682005508518 |

**STOP SIGNAL
PLASTIC SOCET****WOLFRAM 34441**

| | |
|---------------------|------------------------|
| Product Description | Socket Indicator Bulbs |
| Volt | 24 Volt |
| Watt | 1,2W |
| Base | B8,5d |
| Packaging Qty | 10 |
| Product Barcode | 8682005506415 |
| Shipping Qty | 50 |
| Shipping Barcode | 8682005506422 |

**WOLFRAM 34413**

| | |
|---------------------|------------------|
| Product Description | Glass Wedge Base |
| Ece | T10 |
| Volt | 24 Volt |
| Watt | 3 Watt |
| Base | W2.1x9.5d |
| Packaging Qty | 10 |
| Product Barcode | 8682005501861 |
| Shipping Qty | 50 |
| Shipping Barcode | 8682005508525 |

**WOLFRAM 34415**

| | |
|---------------------|------------------|
| Product Description | Glass Wedge Base |
| Ece | T10 |
| Volt | 24 Volt |
| Watt | 5 Watt |
| Base | W2.1x9.5d |
| Packaging Qty | 10 |
| Product Barcode | 8682005501878 |
| Shipping Qty | 50 |
| Shipping Barcode | 8682005508532 |

STOP SIGNAL FESTOON SERIES



WOLFRAM 34615

| | |
|---------------------|---------------|
| Product Description | Festoon 36 mm |
| Ece | C5W |
| Volt | 24 Volt |
| Watt | 5 Watt |
| Base | SV8.5-8 |
| Packaging Qty | 10 |
| Product Barcode | 8682005501892 |
| Shipping Qty | 50 |
| Shipping Barcode | 8682005508556 |



WOLFRAM 34617

| | |
|---------------------|---------------|
| Product Description | Festoon 41 mm |
| Ece | CW10 |
| Volt | 24 Volt |
| Watt | 10 Watt |
| Base | SV8.5-8 |
| Packaging Qty | 10 |
| Product Barcode | 8682005501908 |
| Shipping Qty | 50 |
| Shipping Barcode | 8682005508563 |



MOTORCYCLE LIGHTING

HEADLIGHT SERIES**WOLFRAM 22302**

| | |
|---------------------|----------------|
| Product Description | Standard Light |
| Ece | S2 |
| Volt | 12 Volt |
| Watt | 35/35 Watt |
| Base | BA20d |
| Packaging Qty | 1 |
| Product Barcode | 8682005501120 |
| Bundle Qty | 10 |
| Bundle Barcode | 8682005504459 |
| Shipping Qty | 100 |
| Shipping Barcode | 8682005507788 |

**WOLFRAM 22314**

| | |
|---------------------|----------------|
| Product Description | Standard Light |
| Ece | HS1 |
| Volt | 12 Volt |
| Watt | 35/35 Watt |
| Base | PX43t |
| Packaging Qty | 1 |
| Product Barcode | 8682005501137 |
| Bundle Qty | 10 |
| Bundle Barcode | 8682005504466 |
| Shipping Qty | 100 |
| Shipping Barcode | 8682005507795 |

**WOLFRAM 22315**

| | |
|---------------------|----------------|
| Product Description | Standard Light |
| Ece | HS5 |
| Volt | 12 Volt |
| Watt | 35/30 Watt |
| Base | P23TPCX |
| Packaging Qty | 1 |
| Product Barcode | 8682005508648 |
| Bundle Qty | 10 |
| Bundle Barcode | 8682005508655 |
| Shipping Qty | 100 |
| Shipping Barcode | 8682005508662 |

STOP SIGNAL SERIES**WOLFRAM 27867**

| | |
|---------------------|---------------|
| Product Description | Metal Base |
| Ece | R5W |
| Volt | 12 Volt |
| Watt | 5 Watt |
| Base | BA15s |
| Packaging Qty | 10 |
| Product Barcode | 8682005501304 |
| Shipping Qty | 50 |
| Shipping Barcode | 8682005507962 |

**WOLFRAM 27893**

| | |
|---------------------|---------------|
| Product Description | Metal Base |
| Ece | P21W |
| Volt | 12 Volt |
| Watt | 21 Watt |
| Base | BA15s |
| Packaging Qty | 10 |
| Product Barcode | 8682005501335 |
| Shipping Qty | 50 |
| Shipping Barcode | 8682005507993 |

**WOLFRAM 27916**

| | |
|---------------------|---------------|
| Product Description | Metal Base |
| Ece | P21/5W |
| Volt | 12 Volt |
| Watt | 21/5 Watt |
| Base | BAY15d |
| Packaging Qty | 10 |
| Product Barcode | 8682005501359 |
| Shipping Qty | 50 |
| Shipping Barcode | 8682005508013 |

NEW SERIES

LED LIGHTING

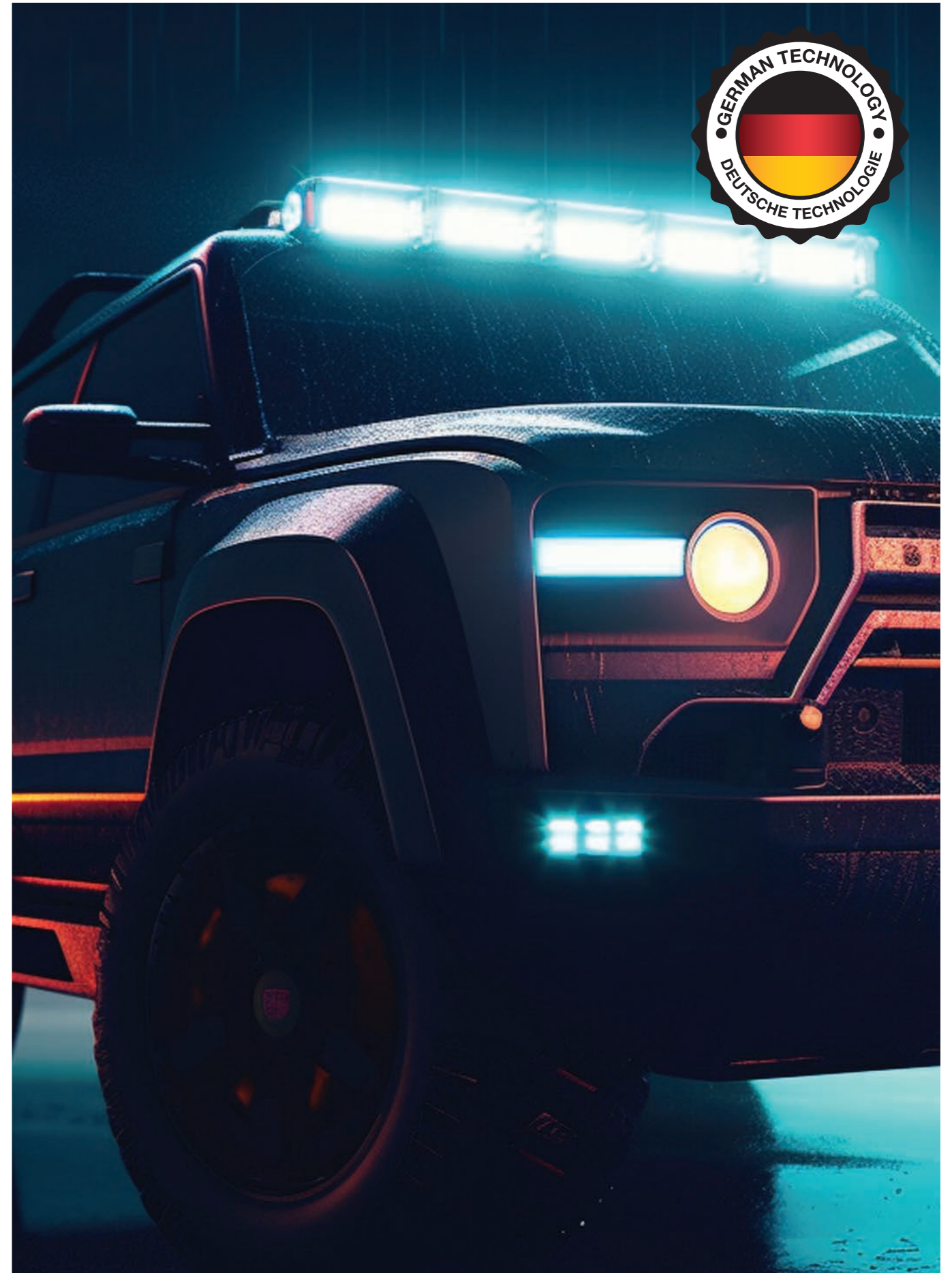

AUTOMOTIVE BEACON WARNING LAMP

LED WARNING LIGHTBAR



WOLFRAM 31103

| | |
|------------------------------|-----------------------------------|
| Product Description | Automotive Beacon Warning Lamp |
| Led Qty | 48 Leds |
| Voltage | 12-24V |
| Watt | 48W |
| Power | 1Watt Led Chips |
| Mounting Way | 5Pcs In 1 Maganet Mounting |
| Material | Pc |
| Size | 15Cmx15cmx12cm |
| Flash Pattern | 10 |
| Color | Amber |
| Long Life | 65.000 Hours |
| Operating Temperature | : -42 C/+67 C |
| Product Barcode | 8682005502950 |

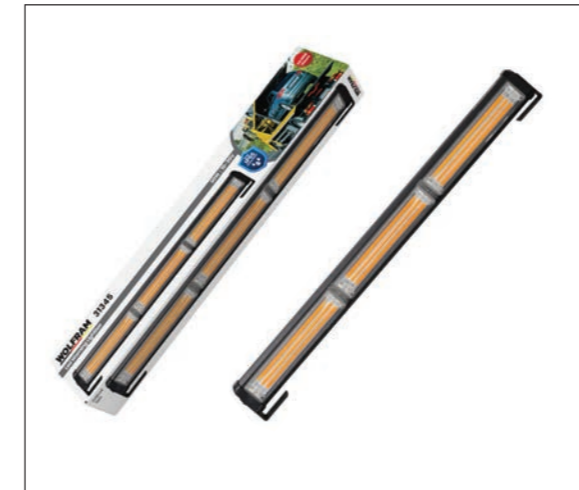

WOLFRAM 31345

| | |
|----------------------------|---------------------------|
| Product Description | Led Warning Lightbar |
| Led | 3Cob X 10W Amber |
| Power | 30W |
| Voltage | 10-30V |
| Waterproof | Ip65 |
| Size | 45,8 Cm X 5,5 Cm X 4,5 Cm |
| Material | Pc+Aluminum |
| Life | 50.000 Hours |
| Flash | 14 Flash |
| Switch | 3,5M Wire+On/Off Plug |
| Certificate | 10R-06 E9 23594 |
| Product Barcode | 8682005502974 |



WOLFRAM 31120

| | |
|----------------------------|-----------------------------------|
| Product Description | Automotive Beacon Warning Lamp |
| Led Qty | 48 Leds |
| Voltage | 12-24V |
| Watt | 48W |
| Power | 1Watt Led Chips |
| Mounting Way | Bracket Mounting |
| Material | Pc |
| Size | 13Cmx13cmx21cm |
| Flash Pattern | 10 |
| Color | Amber |
| Long Life | 65.000 Hours |
| Connection Bracket | |
| Product Barcode | 8682005502967 |



WOLFRAM 31361

| | |
|----------------------------|-----------------------|
| Product Description | Led Warning Lightbar |
| Led | 4Cob X 10W Amber |
| Power | 40W |
| Voltage | 10-30V |
| Waterproof | Ip65 |
| Size | 61Cm X 5,5Cm X 4,5Cm |
| Material | Pc+Aluminum |
| Life | 50.000 Hours |
| Flash | 14 Flash |
| Switch | 3,5M Wire+On/Off Plug |
| Certificate | 10R-06 E9 23594 |
| Product Barcode | 8682005502981 |



WOLFRAM 31225

| | |
|----------------------------|---------------------|
| Product Description | Rotating Lamp Mount |
| Product Barcode | 8682005508778 |



WOLFRAM 31376

| | |
|----------------------------|-----------------------|
| Product Description | Led Warning Lightbar |
| Led | 5Cob X 10W Amber |
| Power | 50W |
| Voltage | 10-30V |
| Waterproof | Ip65 |
| Size | 8,68201E+12 |
| Material | Pc+Aluminum |
| Life | 50.000 Hours |
| Flash | 14 Flash |
| Switch | 3,5M Wire+On/Off Plug |
| Certificate | 10R-06 E9 23594 |
| Product Barcode | 8682005502998 |

LED WARNING LIGHTBAR



WOLFRAM 31391

Product Description Led Warning Lightbar
Led 6Cob X 10W Amber
Power 60W
Voltage 10-30V
Waterproof Ip65
Size 91 Cm X 5,5 Cm X 4,5Cm
Material Pc+Aluminum
Life 50.000 Hours
Flash 14 Flash
Switch 3,5M Wire+On/Off Plug
Certificate 10R-06 E9 23594
Product Barcode 8682005503001



WOLFRAM 31545

Product Description Led Warning Lightbar
Led 18 Led X 1W Amber
Power 18W
Voltage 10-30V
Waterproof Ip65
Size 45,8 Cm X 5,5Cm X 4,5Cm
Material Pc+Aluminum
Life 50.000 Hours
Flash 14 Flash
Switch 3,5M Wire+On/Off Plug
Certificate 10R-06 E9 23594
Product Barcode 8682005503032



WOLFRAM 31406

Product Description Led Warning Lightbar
Led 7Cob X 10W Amber
Power 70W
Voltage 10-30V
Waterproof Ip65
Size 106 Cm X 5,5Cm X 4,5Cm
Material Pc+Aluminum
Life 50.000 Hours
Flash 14 Flash
Switch 3,5M Wire+On/Off Plug
Certificate 10R-06 E9 23594
Product Barcode 8682005503018



WOLFRAM 31561

Product Description Led Warning Lightbar
Led 24 Led X 1W Amber
Power 24W
Voltage 10-30V
Waterproof Ip65
Size 61Cm X 5,5Cm X 4,5Cm
Material Pc+Aluminum
Life 50.000 Hours
Flash 14 Flash
Switch 3,5M Wire+On/Off Plug
Certificate 10R-06 E9 23594
Product Barcode 8682005503049



WOLFRAM 31418

Product Description Led Warning Lightbar
Led 8Cob X 10W Amber
Power 80W
Voltage 10-30V
Waterproof Ip65
Size 118,5Cm X 5,5Cm X 4,5Cm
Material Pc+Aluminum
Life 50.000 Hours
Flash 14 Flash
Switch 3,5M Wire+On/Off Plug
Certificate 10R-06 E9 23594
Product Barcode 8682005503025



WOLFRAM 31576

Product Description Led Warning Lightbar
Led 30 Led X 1W Amber
Power 30W
Voltage 10-30V
Waterproof Ip65
Size 76 Cm X 5,5Cm X 4,5Cm
Material Pc+Aluminum
Life 50.000 Hours
Flash 14 Flash
Switch 3,5M Wire+On/Off Plug
Certificate 10R-06 E9 23594
Product Barcode 8682005503056

LED WARNING LIGHTBAR



WOLFRAM 31591

Product Description Led Warning Lightbar
Led 36 Led X 1W Amber
Power 36W
Voltage 10-30V
Waterproof Ip65
Size 91 Cm X 5,5Cm X 4,5Cm
Material Pc+Aluminum
Life 50.000 Hours
Flash 14 Flash
Switch 3,5M Wire+On/Off Plug
Certificate 10R-06 E9 23594
Product Barcode 8682005503063

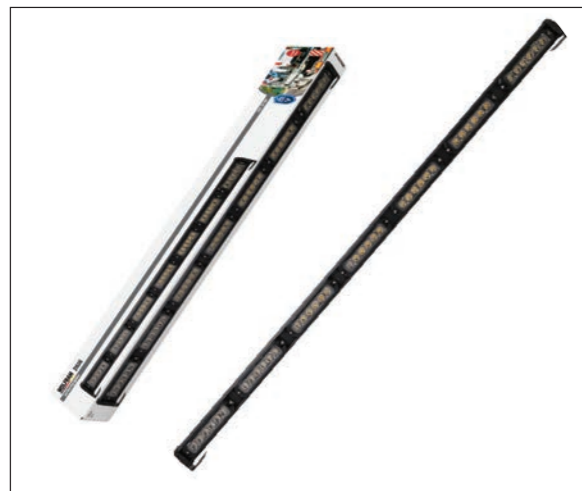

WOLFRAM 31606

Product Description Led Warning Lightbar
Led 42 Led X 1W Amber
Power 42W
Voltage 10-30V
Waterproof Ip65
Size 106Cm X 5,5Cm X 4,5Cm
Material Pc+Aluminum
Life 50.000 Hours
Flash 14 Flash
Switch 3,5M Wire+On/Off Plug
Certificate 10R-06 E9 23594
Product Barcode 8682005503070



WOLFRAM 31618

Product Description Led Warning Lightbar
Led 48 Led X 1W Amber
Power 48W
Voltage 10-30V
Waterproof Ip65
Size 118,5 Cm X 5,5Cm X 4,5Cm
Material Pc+Aluminum
Life 50.000 Hours
Flash 14 Flash
Switch 3,5M Wire+On/Off Plug
Certificate 10R-06 E9 23594
Product Barcode 8682005503087

LED WORKING LIGHT



WOLFRAM 31820

Product Description 3 Led Forklift Safety Light Red
Led 3Ledx3w Red
Power 9W
Voltage 10-110V
Waterproof Ip67
Material Pc+Aluminum
Life 50.000 Hours
Lumen 1800Lm
Certificate 10R-06 E9 23594
Product Barcode 8682005503094



WOLFRAM 31826

Product Description 2 Led Forklift Safety Light Blue
Led 2Led X 10W Blue
Power 20W
Voltage 10-110V
Waterproof Ip67
Material Pc+Aluminum
Life 50.000 Hours
Lumen 1800 Lm
Certificate 10R-06 E9 23594
Product Barcode 8682005503100



WOLFRAM 31901

Product Description 9 Led Work Lamp White
Led 9Led X 3W White
Power 27W+6W
Voltage 10-30V
Waterproof Ip67
Material Pc+Aluminum
Life 50.000 Hours
Lumen 2400 Lm
Certificate 10R-06 E9 23594
Product Barcode 8682005503117



WOLFRAM 31903

Product Description 9 Led Work Lamp White-Red
Led 9Led X 3W White
 6Led X 1W Red
Power 27W+6W
Voltage 10-30V
Waterproof Ip67
Material Pc+Aluminum
Life 50.000 Hours
Lumen 2400 Lm
Certificate 10R-06 E9 23594
Product Barcode 8682005503124

PRODUCTION PHOTOS

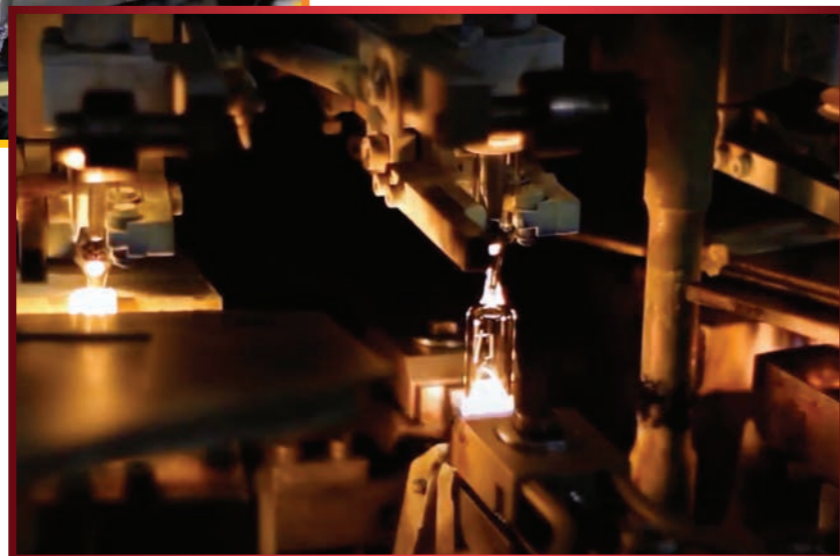
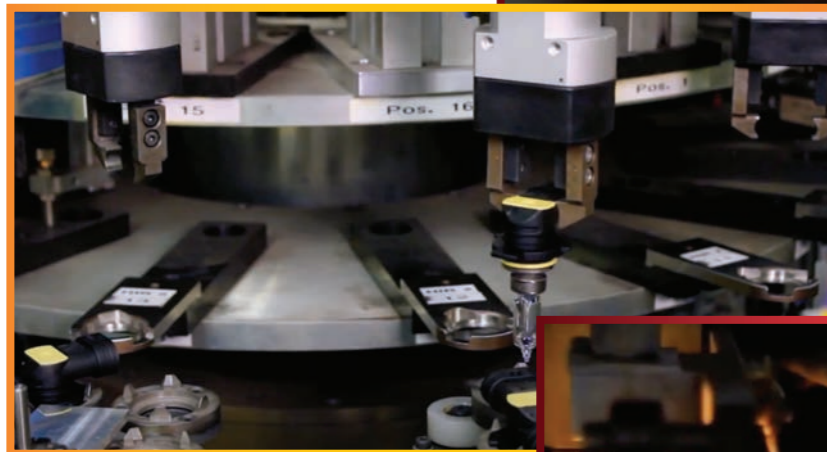
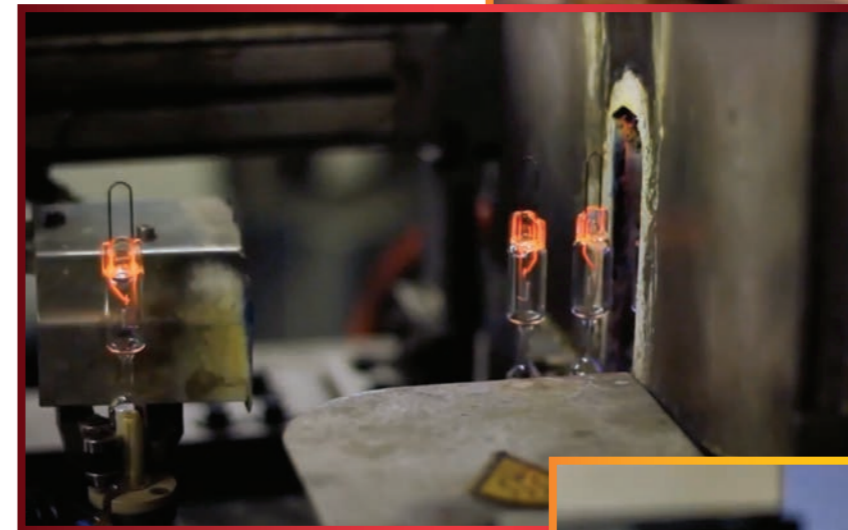
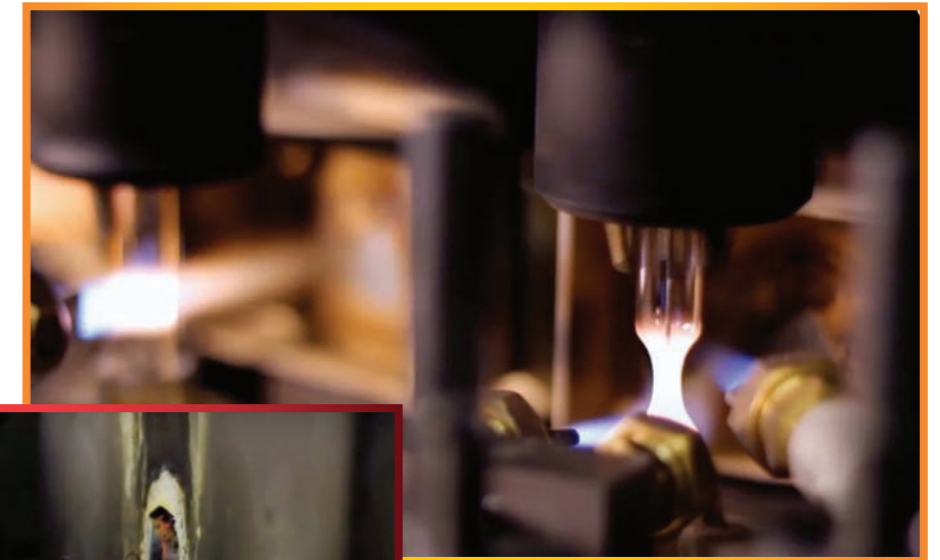
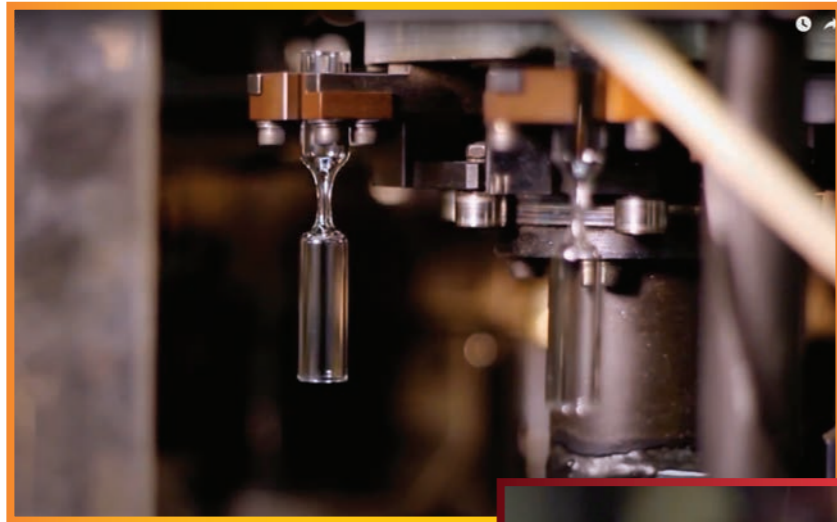

WOLFRAM



WOLFRAM Automotive Bulbs
Dorotheen Str Düsseldorf - Germany
T: (+49) 151 47114400
www.wolframgermany.com
info@wolframgermany.com
www.instagram.com/wolframgermany